

chairs  
armchairs  
recliners  
lounge seating  
tables

//

**hospitality  
and healthcare**  
collection

//

care



**MISSION**

**MISSÃO**

Identify our clients needs. Design and produce custom made chairs for any part of the world.

Offer a unique global quality service based on the professionalism and commitment of the entire team, establishing a relationship of complete trust.

Identificar o que o nosso cliente pretende. Criar e produzir cadeiras personalizadas para qualquer parte do mundo.

Oferecer um serviço único de qualidade global, apoiado no profissionalismo e compromisso de toda a equipa, estabelecendo uma relação de confiança.

**Overview**

**chairs | cadeiras**

	pag
adel	<b>06-11</b>
ava	<b>62-64</b>
care	<b>38-43</b>
denise	<b>32-33</b>
faro	<b>12-21</b>
flower	<b>56-57</b>
gaudi bx	<b>59-61</b>
jupiter	<b>55</b>
katia	<b>28-31</b>
nyg	<b>58</b>
petra	<b>34-35</b>
porto	<b>22-23</b>
sagres	<b>44-49</b>
sevilha	<b>26-27</b>
vida	<b>50-55</b>
voip	<b>24-25</b>

**dining tables | mesas de jantar**

dona	<b>68</b>
donasella	<b>68-69</b>
erg	<b>70</b>
tess	<b>69-70</b>

**side tables | mesas de apoio**

geo wire	<b>71</b>
carter	<b>71</b>

chairs and armchairs | cadeiras e cadeirões

**adel**  
06|11



**flower**  
56|57



**sagres**  
44|49



**ava**  
62|64



**gaudi bx**  
59|61



**sevilha**  
26|27



**care**  
38|43



**jupiter**  
55



**vida**  
50|55



**denise**  
32|33



**nyg**  
58



**voip**  
24|25



**faro**  
12|21



**katia**  
28|31



tables | mesas

**carter**  
71



**porto**  
22|23



**petra**  
34|35



**geo**  
71



**petra**  
34|35



**petra**  
34|35



**dona**  
68



**petra**  
34|35



**petra**  
34|35



**donasell:**  
68|69



**erg**  
70



**tess**  
69|70



# adel

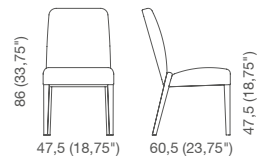

**adel**  
2 x box / 0,36 m<sup>3</sup>-12,67 ft / 5 kg-11 lb

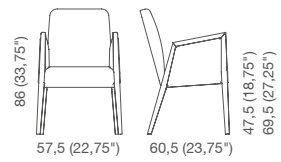

**adel cb**  
1 x box / 0,34 m<sup>3</sup>-12,18 ft / 7 kg-15,4 lb

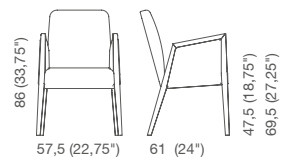

**adel maple mad**  
1 x box / 0,34 m<sup>3</sup>-12,18 ft / 11,5 kg-25,4 lb



adel

adel cb

adel maple mad



# adel mass

by area44



adel mass cb



adel mass

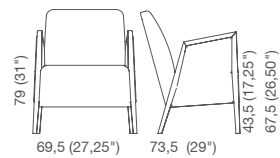

adel mass/ adel mass cb  
1 x box /0,48 m³-17,07 ft /11,5 kg-25,4 lb

single  
it's fine,  
but double  
is even better!

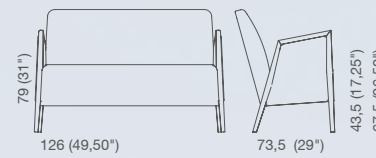

adel sofa  
1 x box /0,68 m³-24,05 ft /13 kg-28,7 lb

# faro

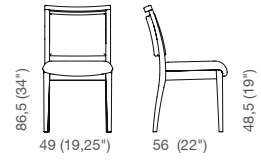

**faro/ faro 01**  
2 x box /0,31 m<sup>3</sup>-10,90 ft /7,5 kg-16,5 lb

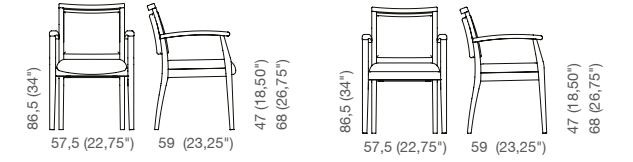

**faro emp cb**  
1 x box /0,34 m<sup>3</sup>-12,18 ft /9 kg-19,8 lb

**faro emp 01 cb**  
1 x box /0,34 m<sup>3</sup>-12,18 ft /9 kg-19,8 lb



faro 01



faro emp cb

faro emp 01 cb



faro 01 maple



faro maple



faro maple est



faro est mad 01 maple



faro est mad maple

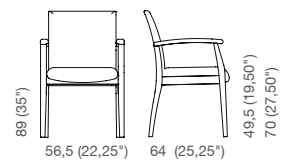

**faro 01 maple/ faro maple**  
1 x box /0,35 m<sup>3</sup>-12,22 ft /10 kg-22,1 lb

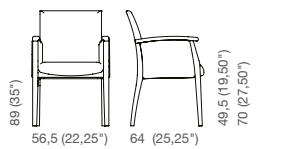

**faro est mad 01maple/ faro est mad maple**  
1 x box /0,35 m<sup>3</sup>-12,22 ft /12 kg-26,5 lb

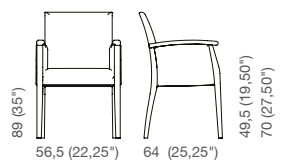

**faro est maple/ faro est 01 maple**  
1 x box /0,35 m<sup>3</sup>-12,22 ft /12 kg-26,5 lb



faro est maple

faro est 01 maple





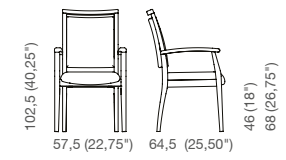

faro high emp 01 cb/ faro high emp cb  
1 x box / 0,42 m³ 14,88 ft³ / 9 kg 19,8 lb



faro high emp 01 cb



faro high emp cb

# faro mass

the difference it's an easthetic detail



faro mass est mad

faro mass est

the perfect element.  
a wise way of defining a space.

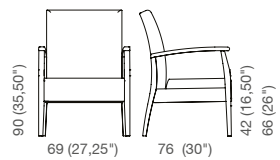

**faro mass**  
1 x box /0,63 m² 22,37 ft /14 kg 30,9 lb

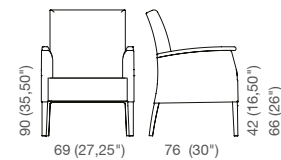

**faro mass est mad/ faro mass est**  
1 x box /0,63 m² 22,37 ft /19 kg 41,9 lb

porto

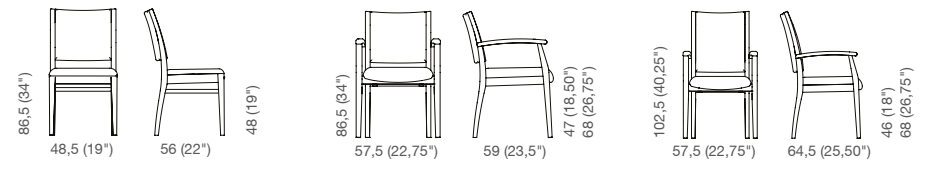

**porto 01**  
2 x box /0,31 m³-10,9 ft /7,5 kg-16,5 lb

**porto emp cb**  
1 x box /0,34 m³-12,18 ft /9 kg-19,8 lb

**porto high emp cb**  
1 x box /0,42 m³-14,88 ft /9 kg-19,8 lb



porto 01

porto emp cb

porto high emp cb

care catalogue 2018

# voip

care catalogue 2018



voip

carter 200

voip cb

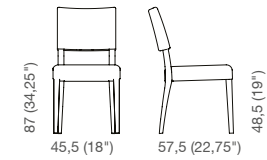

**voip**  
2 x box /0,31 m<sup>3</sup>-10,90 ft /6,5 kg-14,3 lb

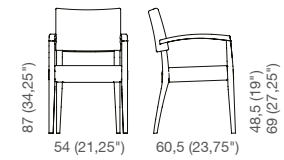

**voip cb**  
1 x box /0,34 m<sup>3</sup>-12,18 ft /8 kg-17,6 lb

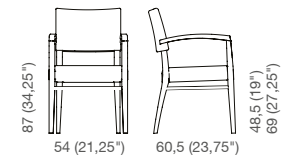

**voip emp tp cb**  
1 x box /0,34 m<sup>3</sup>-12,18 ft /8 kg-17,6 lb

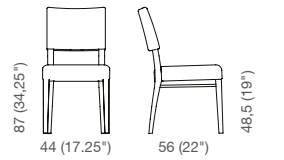

**voip emp tp**  
1 x box /0,31 m<sup>3</sup>-10,90 ft /6,5 kg-14,3 lb



voip cb



voip emp tp cb



voip emp tp

# sevilha

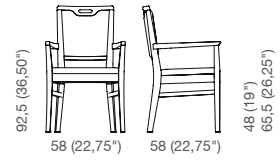

**sevilha zu 01 cb/ sevilha zu rod cb**  
1 x box /0,37 m<sup>3</sup> 12,97 ft /9 kg 19,8 lb

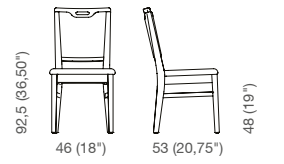

**sevilha zu 01**  
2 x box /0,31 m<sup>3</sup> 10,90 ft /7 kg 15,4 lb



sevilha zu 01 cb

sevilha zu 01 rod cb



sevilha zu 01

# katia

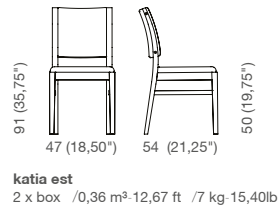

katia est

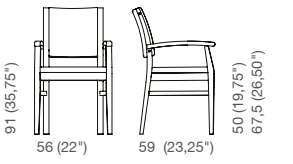

**katia est cb**  
1 x box /0,37 m³-12,97 ft /8 kg-17,6 lb

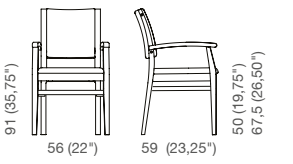

**katia est emp cb**  
1 x box /0,37 m³-12,97 ft /9 kg-19,8 lb



katia est cb

katia est emp cb

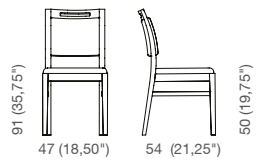

**katia zu**  
2 x box /0,36 m³-12,67 ft /7 kg-15,4 lb

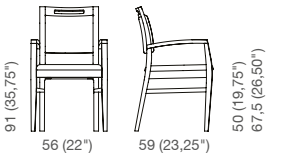

**katia zu cb**  
1 x box /0,37 m³-12,97 ft /8 kg-17,6 lb

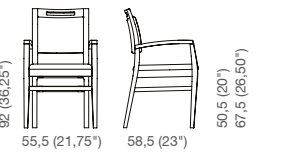

**katia zu emp cb**  
1 x box /0,37 m³-12,97 ft /8,5 kg-18,7 lb



katia zu



katia zu emp cb



katia zu cb



# denise

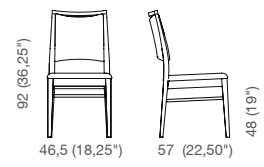

**denise emp**  
2 x box /0,31 m<sup>3</sup>-10,90 ft /7,5 kg-16,5 lb

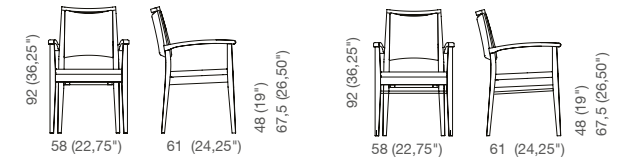

**denise 01 cb**  
1 x box /0,37 m<sup>3</sup>-12,97 ft /8,5 kg-18,7 lb

**denise emp tp rod cb**  
1 x box /0,37 m<sup>3</sup>-12,97 ft /8 kg-17,6 lb



denise emp



denise emp tp rod cb

denise 01 cb

# petra

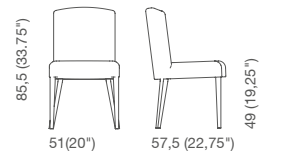

**petra cb**  
2 x box / 0,35 m<sup>2</sup>-12,36 ft / 6,5 kg-14,3 lb

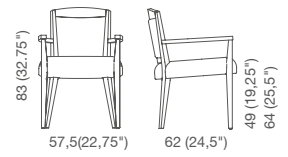

**petra cb**  
1 x box / 0,34 m<sup>2</sup>-11,94 ft / 6,5 kg-14,3 lb

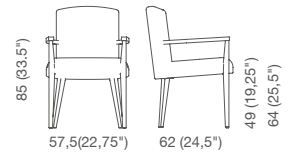

**petra dan cb**  
1 x box / 0,34 m<sup>2</sup>-12 ft / 6,5 kg-14,3 lb

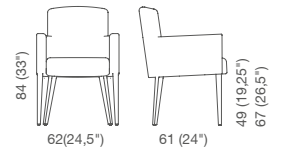

**petra maple/ petra maple mad**  
1 x box / 0,33 m<sup>2</sup>-12,18 ft / 7,5 kg-16,5 lb



petra



petra cb



petra dan cb



petra maple



petra maple mad



# petra mass

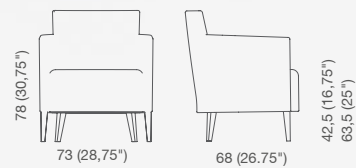

**petra mass**  
1 x box / 0,46 m³-16,20 ft³ / 15,5 kg-34,2 lb

# petra double

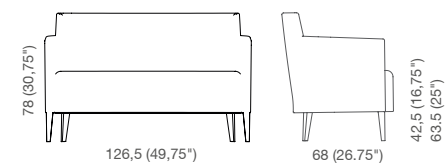

**petra double**  
1 x box / 1,27 m³-44,87 ft³ / 22 kg-48,5 lb

# care front bed

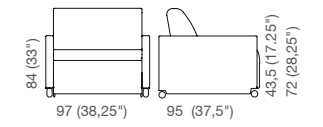

**care front bed**  
1 x box / 0,87 m³ 28,57 ft / 71 kg 156,5 lb



# care side bed

care catalogue 2018

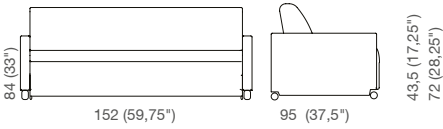

**care side bed**  
1 x hnx / 1,26 m³ 44 R2 ft / R5 kn-1R7 4 lb





# sagres

care catalogue 2018



sagres cb

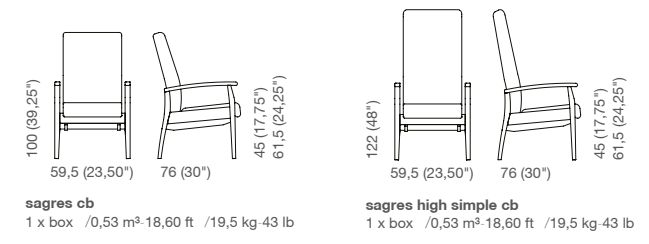

sagres cb

sagres high simple cb

# sagres high

care catalogue 2018



sagres high rp cb



sagres high cb

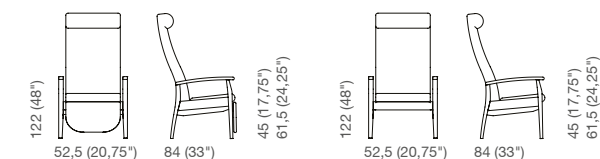

**sagres high rp cb**  
1 x box /0,61 m<sup>2</sup>-21,43 ft /26 kg-57,3 lb

**sagres high cb**  
1 x box /0,61 m<sup>2</sup>-21,43 ft /26 kg-57,3 lb



sagres high rp cb





# sagres relax

care catalogue 2018

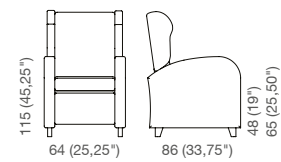

**sagres relax**  
1 x box / 0,68 m<sup>3</sup> 23,96 ft / 36 kg 79,4 lb

# vida elevation

care catalogue 2018

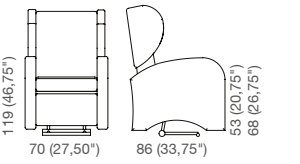

**vida elevation**  
1 x box / 0,78 m³ / 27,47 ft³ / 40 kg / 88,2 lb



# vida plus

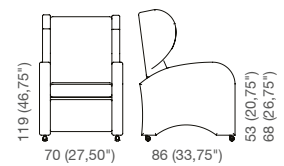

**vida plus**  
1 x box / 0,68 m<sup>2</sup>-23,96 ft / 36 kg-79,4 lb

# vida confort

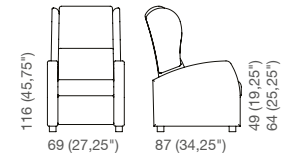

**vida confort**  
1 x box / 0,60 m³ 21,08 ft / 35 kg 77,2 lb



in  
all its  
simplicity  
provides  
surprising  
comfort.

lounge

jupiter

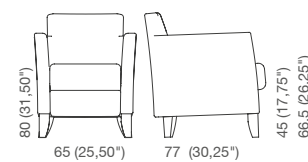

**jupiter**  
1 x box / 0,46 m<sup>2</sup>-16,10 ft / 14,5 kg 32 lb



# flower

care catalogue 2018



flower lounge

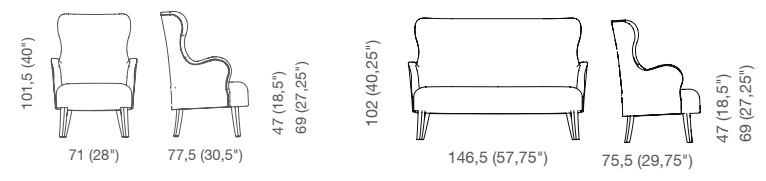

**flower lounge**  
1 x box /0,60 m³ 22,08 ft /13,5 kg - 29,8 lb

**flower double**  
1 x box /1,27 m³ 44,87 ft /14,5 kg - 32 lb



flower double

# nyg mass nyg puff

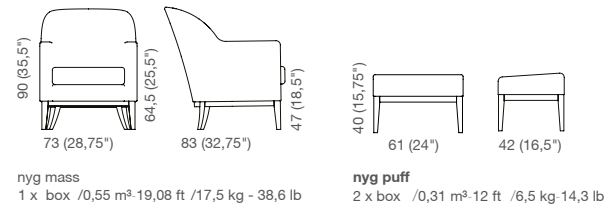

# gaudi bx

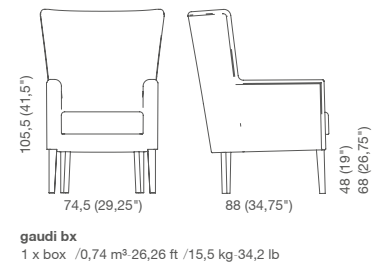

# gaudi bx amov

care catalogue 2018

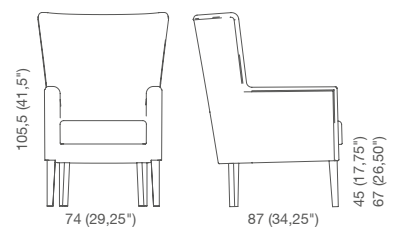

**gaudi bx amov**  
1 x box / 0,81 m³ 28,45 ft / 15,5 kg 34,2 lb



ava

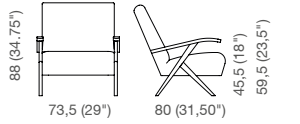

**ava lounge**  
1 x box / 0,63 m<sup>3</sup> 22,37 ft / 18,5 kg 40,8 lb



# ava double

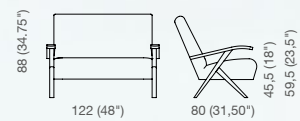

**ava double**  
1 x box / 0,93 m³ 32,99 ft / 26 kg 57,3 lb

tables  
-  
mesas

# dona quad



## dining table | mesa de jantar

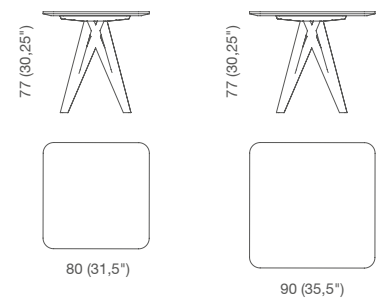

**MQ 07T1**  
dona quad  
1 x box /0,49 m<sup>3</sup> - 17,3 ft  
15,9 kg - 35 lb

**MQ 07T1**  
dona quad  
1 x box /0,63 m<sup>3</sup> - 22,25 ft  
19,3 kg - 42,5 lb

# donasella rect



## dining table | mesa de jantar

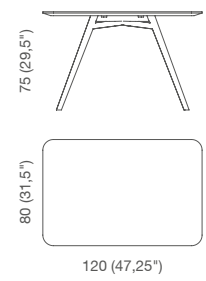

**MR 07T3**  
donasella rect  
1 x box /0,71 m<sup>3</sup> - 25,1 ft  
20,4 kg - 45 lb

# dona rect



care catalogue 2018

## dining table | mesa de jantar

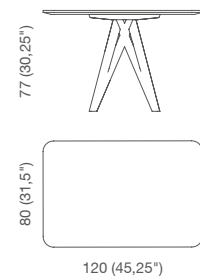

**MR 07T0**  
dona rect  
1 x box /0,74 m<sup>3</sup> - 26,25 ft  
20,4 kg - 45 lb

# tess quad (pe k)



**MD 09C2**  
available with square leg  
disponível com pé quadrado

## dining table | mesa de jantar

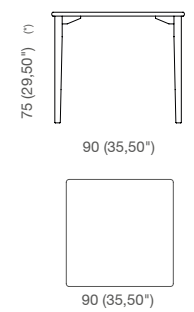

(\*) measure without top  
medida sem tampo

**MQ 044V**  
tess quad  
1 x box /0,11 m<sup>3</sup> - 3,9 ft  
20 kg - 44,1 lb

# donasella quad



## dining table | mesa de jantar

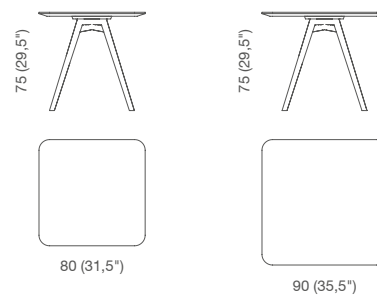

**MQ 07T4**  
donasella quad  
1 x box /0,48 m<sup>3</sup> - 16,95 ft  
13,6 kg - 30 lb

**MQ 07T4**  
donasella quad  
1 x box /0,61 m<sup>3</sup> - 21,54 ft  
16,8 kg - 37 lb

# tess red (pe k)



**MD 09C2**  
available with square leg  
disponível com pé quadrado

## dining table | mesa de jantar

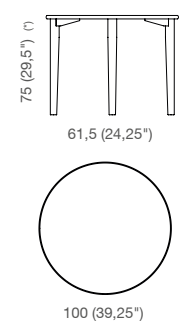

(\*) measure without top  
medida sem tampo

**MD 044V**  
tess red  
1 x box /0,13 m<sup>3</sup> - 4,6 ft  
17 kg - 37,5 lb

# tess rect (pe k)



**MD 09C2**  
available with square leg  
disponível com pé quadrado

## dining table | mesa de jantar

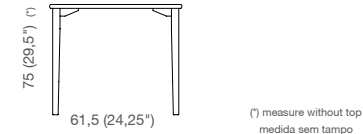

**MR 044V**  
tess rect  
1 x box /0,13 m<sup>3</sup> - 4,6 ft  
17 kg - 37,5 lb

# geo



geo h44      geo h51      geo h62

## coffee - side table | mesa de apoio

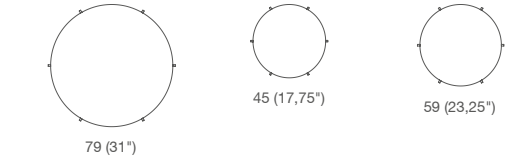
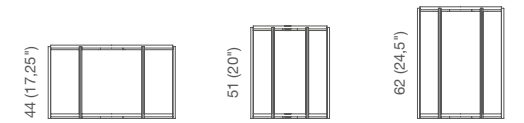

**MD 08P0**  
geo h44  
1 x box /0,36 m<sup>3</sup> - 12,71 ft  
16,4 kg - 36,2 lb

**MD 05T2**  
geo h51  
1 x box /0,14 m<sup>3</sup> - 4,44 ft  
7,8 kg - 17,2 lb

**MD 08P1**  
geo h62  
1 x box /0,27 m<sup>3</sup> - 9,54 ft  
10,3 kg - 22,7 lb

# erg quad



## dining table | mesa de jantar

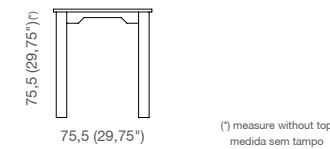

**MQ.0E80**  
erg quad  
1 x box /0,09 m<sup>3</sup> - 3,2ft  
27 kg - 63,9 lb

# carter sp 100



## coffee - side table | mesa de apoio

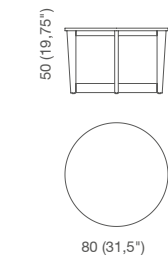

**MD 0275**  
carter sp100  
1 x box /0,24 m<sup>3</sup> - 11,3 ft  
19 kg - 41,9 lb

# erg rect



## dining table | mesa de jantar

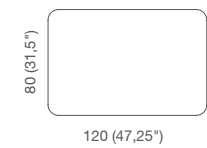
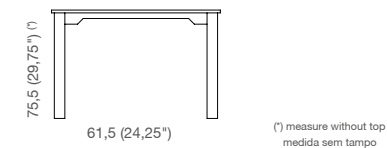

**MR.0E80**  
erg rect  
1 x box /0,14 m<sup>3</sup> - 4,94 ft  
29 kg - 63,9 lb

# carter 200



## coffee - side table | mesa de apoio

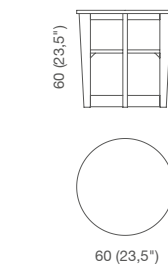

**MD 0277**  
carter 200  
1 x box /0,24 m<sup>3</sup> - 8,5 ft  
10,5 kg - 23,1 lb

TABLE TOPS  
TAMPOS

VENEERED MDF WITH EDGE

mdf folheado c/orla  
mdf plaqué avec chant  
mdf furniert mit rand  
dm chapado con canto

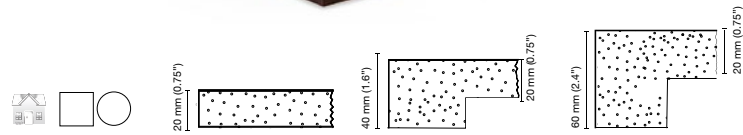

Available Edges | Cantos Disponíveis | Chants Disponibles | verfügbare Kante | Cantos Disponibles



**veneered edge straight corner** | orla folheada canto reto | chant plaqué bord droit | furnierten Rand gerade Kanten canto chapado borde recto

COD. T0131



**solid wood edge straight corner** | orla maciça canto reto | chant massif bord droit | massiven Rand gerade Kanten canto madera maciza borde recto

COD. T0150

LAMINATE WITHOUT EDGE

termolaminado s/orla | stratifié sans chant | thermolaminat ohne rand  
laminado sin canto

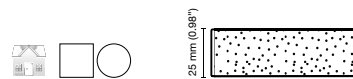

Available Edges | Cantos Disponíveis | Chants Disponibles | verfügbare Kante | Cantos Disponibles



**Plywood rounded edge nr4, rounded corner**  
Contraplacado orla boleada no 4 canto boleado  
Contreplaqué Chant arrondi nr4, bord arrondi  
Sperrholz runder Rand Nr.4, abgerundete Kanten  
Contrachapado canto redondo nr 4, borde redondo

COD. T1976

LAMINATED CHIPBOARD WITH EDGE

aglomerado termolaminado c/orla  
aggloméré stratifié avec chant  
laminierter spanplatte mit rand  
aglomerado laminado con canto

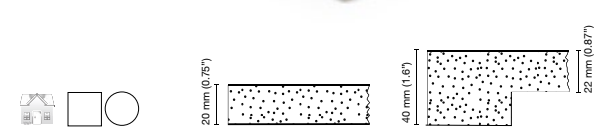

Available Edges | Cantos Disponíveis | Chants Disponibles | verfügbare Kante | Cantos Disponibles



**solid round edge, round corner** | orla boleada maciça canto boleado | chant massif arrondi, bord arrondi | runder Rand massiv, abgerundete Kante canto redondo maciza, borde redondo

COD. T0812



**solid edge, straight corner** | orla maciça canto reto | chant massif, bord droit | Rand massiv, gerade Kante | canto maciza, borde recto

COD. T0122



**PVC 2mm (0.8") edge, straight corner** | orla PVC 2mm canto reto | chant PVC 2mm bord droit PVC-Rand 2mm, gerade Kanten canto PVC 2mm borde recto

COD. T0855

MELAMINE FACED CHIPBOARD WITH EDGE

aglomerado melamina c/orla | aggloméré melaminé avec chant  
spanplatte melamin mit rand | aglomerado melamina con canto

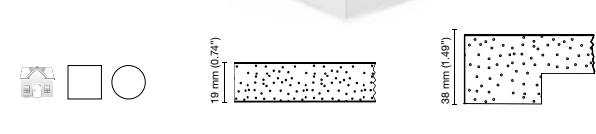

Available Edges | Cantos Disponíveis | Chants Disponibles | verfügbare Kante | Cantos Disponibles



**PVC 2mm (0.8") edge, straight corner**  
orla PVC 2mm canto reto  
chant PVC 2mm bord droit  
PVC-Rand 2mm, gerade Kanten  
canto PVC 2mm borde recto

COD. T0124

laminates | laminados

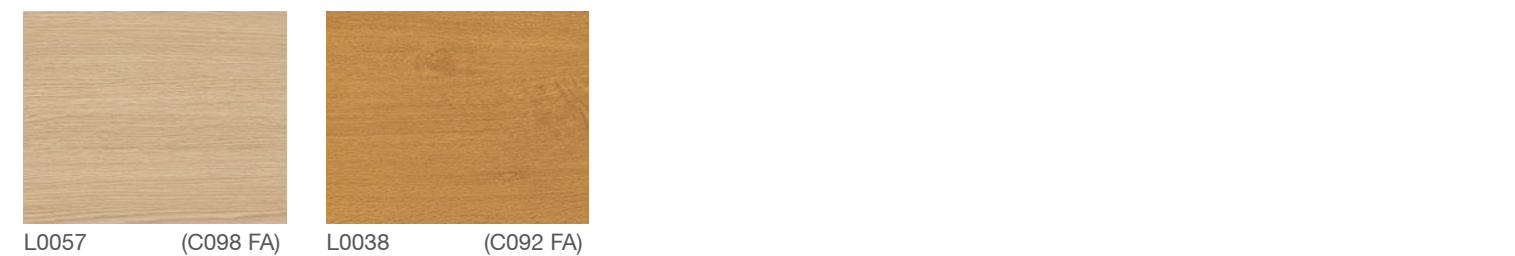
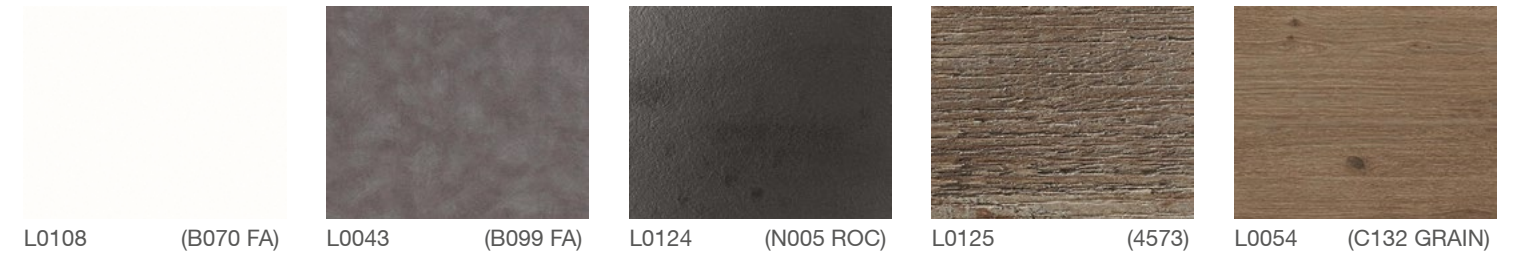

melamine | melamina

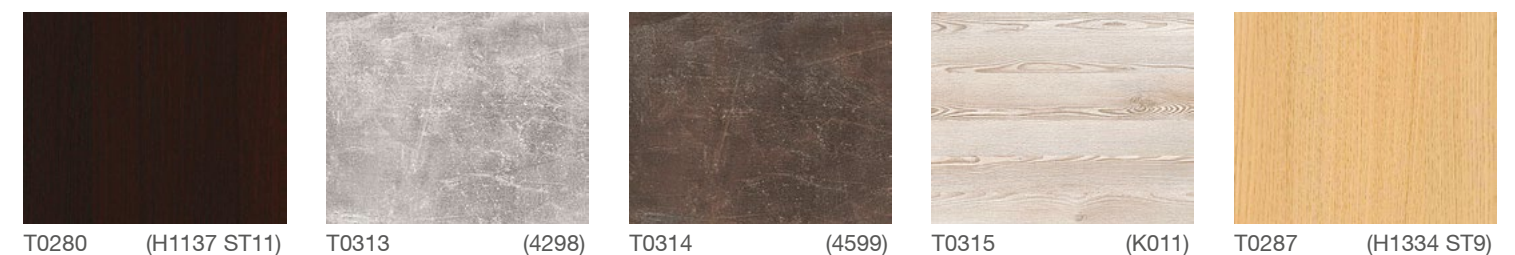
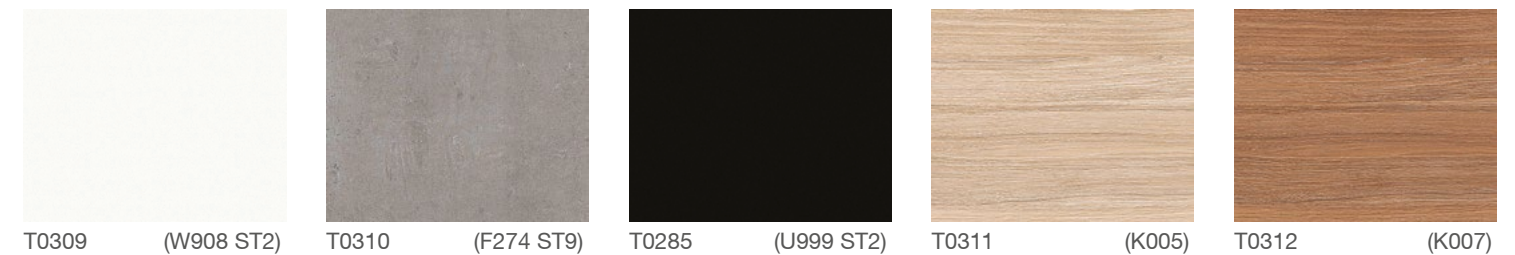

Colours are indicative. All sizes and dimensions could change within the tolerance of 5 mm • As cores são indicativas. Todos os tamanhos podem variar em 5mm • Les coloris sont indicatifs. Les dimensions indiquées peuvent varier ayant une tolérance de ± 5 mm • Farbabweichungen möglich. Alle Abmessungen können in ca. ± 5 mm abweichen • Los colores son indicativos. Las medidas indicadas pueden variar en tolerancia de ± 5 mm

standard colors

beech wood | faia



**C09**  
STEAMED/ VAPORIZADA/ VAPORISÉ/  
GEDÄMPFT/ VAPORIZADA



**C63**  
LIGHT CHERRY/ CEREJEIRA CLARA/  
MEURSIER CLAIR/ KIRSCHHE HELL/ CEREZA  
CLARA



**C113**  
HONEY STAIN/ PINHO MEL/ PIN MIEL/ KIEFER  
HONIG/ PINO MIEL



**C26**  
WALNUT COLOR/ COR NOGUEIRA/ COULEUR  
NOYER/ FARBE WALNUS/ COLOR NOGAL



**C928**  
DOVE GREY/ DOVE CINZA/ GRIS DOVE/ DOVE  
GRAU/ DOVE GRIS



**C20**  
ALASKA GREY/ CINZA ALASKA/ GRIS ALASKA  
ALASKA GRAU/ ALASKA GRIS



**C17**  
PARIS GREY BRUSHED/ CINZA PARIS  
ESCOVADO/ GRIS PARIS BROSSE/ GRAU  
PARIS GEBURSTET/ GRIS PARIS CEPILLADO

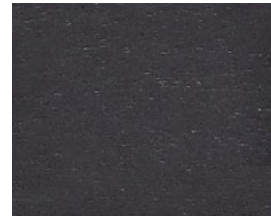

**C118**  
GREY/ CINZA/ GRIS/ GRAU/ GRIS



**C65**  
MOHOGANY/ MOGNO/ ACAJOU/ MAHAGONI/  
CAOBA



**C31**  
BROWN WENGUE/ WENGUE CASTANHO/  
WENGUE MARRON/ WENGÉ BRAUN/ WENGUE  
MARRON



**C32**  
DARK WENGUE/ WENGUE ESCURO/ WENGUE  
FONCÉ/ WENGÉ DUNKEL/ WENGUE NEGRO



**C46**  
BLACK WENGUE/ WENGUE NEGRO/ WENGUE  
NOIR/ SCHWARZ WENGÉ / WENGUE NEGRO

ash wood | freixo

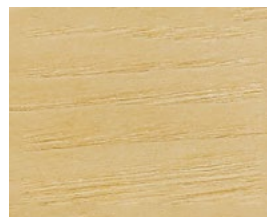

**C44**  
OAK COLOR / COR CARVALHO/ COULEUR  
CHENE/ EICHE FARBE/ COLOR DE ROBLE

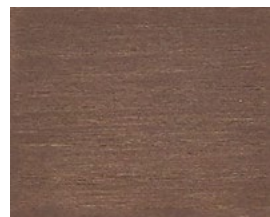

**C112**  
WALNUT COLOR/ COR NOGUEIRA/ COULEUR  
NOYER/ FARBE WALNUS/ COLOR NOGAL



**C704**  
DARK GREY/ CINZA ESCURO/ GRIS FONCÉ/  
DUNKEL GRAU/ GRIS OSCURO

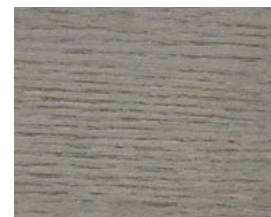

**C17**  
PARIS GRAY BRUSHED/ CINZA PARIS  
ESCOVADO/ GRIS PARIS BROSSE/ GRAU  
PARIS GEBURSTET/ GRIS PARIS CEPILLADO

special colors

beech wood | faia



**C19**  
NATURAL/ NATURAL/ NATUREL/ NATUR/  
NATURAL



**C22**  
STEAMED/ VAPORIZADA/ VAPORISÉ/  
GEDÄMPFT/ VAPORIZADA



**C927**  
IVORY GRAY/ CINZA IVORY/ GRIS IVORY  
IVORY GRAU/ GRIS IVORY



**C174**  
WHITE PAINTED/ BRANCO PINTADO/ PAINT  
BLANC/ WEISS MATT LACKIERT/ BLANCO  
PINTADO



**C926**  
LIGHT LINEN/ LINEN CLARO/ LINEN CLAIR/  
LEINEN HELL/ LINEN CLARO

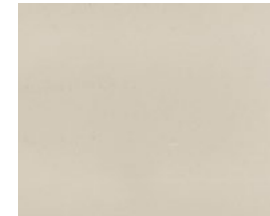

**C18**  
BEIGE / BEGE



**C16**  
LUANDA BEIGE / BEGE LUANDA

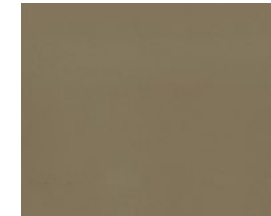

**C42**  
MATT GREYISH GREEN LACQUERED/ OLIVE  
ESCURO LACADO/ LAQUE GRIS OLIVE FONCÉ  
MATE/ GRAUGRÜN DUNKEL MATT LACKIERT/  
LACADO GRIS OLIVA ESCURO MATE



**C85**  
SILVER/ PRATA/ ARGENTÉ/ SILBER/  
PLATEADO



**C68**  
ANTIQUE SILVER/ PRATA VELHO/ VIEUX  
ARGENTÉ/ ANTIK SILBER/ PLATEADO VIEJO



**C593**  
BURNISHED GOLD/ DOURADO TEXTURADO/  
DORÉ TEXTURE/ GOLD TEXTUR/ ORO  
BRUNIDO



**C69**  
ANTIQUE BURNISHED GOLD/ DOURADO  
VELHO TEXTURADO/ VIEUX DORÉ TEXTURE/  
ANTIQUÉ TEXTURGOLD/ DORADO VIEJO

ash wood | freixo



**C27**  
NATURAL/ NATURAL/ NATUREL/ NATUR/  
NATURAL



**C832**  
WHITE BRUSHED/BRANCO ESCOVADO/  
BLANC BROSSE/WEISS GEBÜRSTET /  
BLANCO CEPILLADO



**C28**  
STEAMED / VAPORIZADA / VAPORISÉ /  
GEDÄMPFT / VAPORIZADA



**C929**  
CHARCOAL GREY / CINZA CHARCOAL / GRIS  
CHARCOAL / CHARCOAL GRAU / CHARCOAL  
GRIS



**C924**  
BLUE ANILINE / ANILINE AZUL / BLEU  
ANILINE/ BLAU ANILINE / AZUL ANILINE  
GRIS



**C925**  
GREEN ANILINE / ANILINE VERDE / VERT  
ANILINE / GRÜN ANILINE / VERDE ANILINE

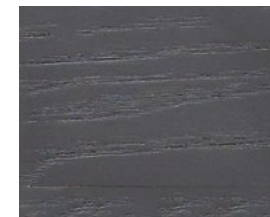

**C922**  
GREY ANILINE/ ANILINE CINZA / GRIS ANILINE  
/ GRAU ANILINE / GRIS ANILINE



**C923**  
RED ANILINE / ANILINE VERMELHO / ROUGE  
ANILINE / ROT ANILINE / ROJO ANILINE

options  
-  
opções

**OPTIONS**

Opções | Options | Optionen | Opciones | 选项



**REMOVABLE SEAT PANEL WITH STAR KNOBS**

Assento removível com manipulo  
Assise amovible avec poignée étoile  
Austauschbarer Sitz durch Sterngriffe  
Asiento amovible con pomo en estrella  
带紧固装置可拆装坐垫板



COD. **AMOV ROS**

**REMOVABLE SEAT PANEL**

Assento removível  
Assise Amovible  
Austauschbarer Sitz  
Asiento amovible  
可拆卸坐垫板

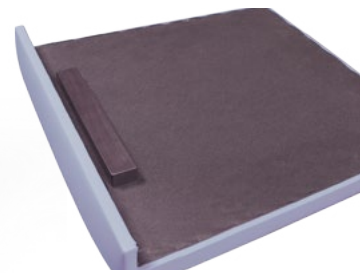

① COD. **AMOV**

**CUSTOM-MADE SEATING**

Assentos | Assises | Sitze | Asientos | 座位定制

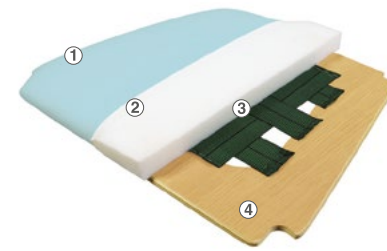

COD.Comfort Plus | EC04

- ① Fabric/Tecido/Tissu/Stoff/Tela/ 面料
- ② Foam/Espuma/Mousse/Schaumstoff/Espuma/海绵  
35/39kgHR-40mm (77.18/86lb-1.6") [E0003A]
- ③ Webbing/Percinta/Sangles/Gurte/Cinchas/ 绷带  
[00011]
- ④ Plywood/Contraplacado/Contreplaqué/Sperrholz/  
Contrachapado/ 胶合板 15 mm (0.6") [CDF15]

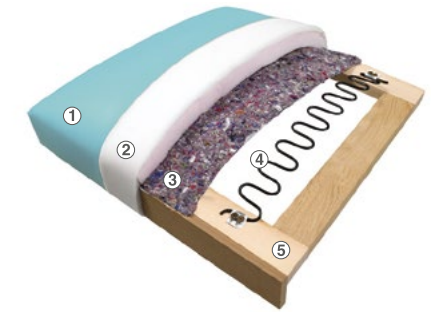

COD.Ultra Comfort | EC05

- ① Fabric/Tecido/Tissu/Stoff/Tela/ 面料
- ② Foam/Espuma/Mousse/Schaumstoff/Espuma/ 海绵  
35/39kgHR-40mm (77.18/86lb-1.6") [E0003A]
- ③ Acrylic Waste Needle Loom Felt/Feltro Agulhado/Feutre  
Aiguilleté/3 Nadelfilz/Fieltro Punzonado/ 晴纶针织
- ④ Nozag Springs/Muelles Zig-Zag/Ressorts No-Sag/  
Zick-zack-Feder/Molas Ziguezague/ S型弹簧 [ZM0049]
- ⑤ Solid Wood Frame/Grade Madeira/Cadre en Bois/  
Holzrahmen/Bastidor de Madera/ 木框架  
22 mm (0.9") [GC000]

**GLIDES**

Deslizadores | Patins | Gleiter | Tacos | 防滑贴



COD.DES01  
White Plastic & Felt  
Plástico Branco & feltro  
Plastique Blanc & Feutre  
Nylon weiß & Filz  
Plástico Blanco & Fielro  
白色塑料&毛毡



COD.DES02  
Brown Plastic & Felt  
Plástico Castanho & Feltro  
Brown Plastic & Felt  
Plástico Castanho & Feltro  
Plastique Marron & Feutre  
Nylon braun & Filz  
Plástico Marón & Fielro  
棕色塑料&毛毡



COD.DES03  
Plastic & Metal  
Plástico & Metal  
Plastique & Metal  
Nylon & Metal  
Plástico & Metal  
塑料&金属



COD.DES04  
White Plastic  
Plástico Branco  
Plastique Blanc  
Nylon weiß  
Plástico Blanco  
白色塑料



COD.DES05  
Brown Plastic  
Plástico Castanho  
Plastique Marron  
Nylon braun  
Plástico Marón  
棕色塑料



COD.DES33  
Teflon

COD.DES01; COD.DES02  
Wood - Parquet Flooring / Pavimento Madeira -  
Parket / Sol Bois - Parquet Flottant / Holz- und  
Parkettboden / Piso Madera - Parquet  
实木 - 拼花地板

COD.DES03  
Carpet Flooring /  
Pavimento Carpete /  
Sol Moquette / Tapis /  
Teppichboden /  
Piso Alfombra / 地毯

COD.DES04; COD. DES05  
Tiles Flooring / Pavimento Cerámico  
Sol Céramique / Fließboden / Piso Ceramica  
瓷砖地面

COD.DES33  
Wood - Parquet Flooring  
Pavimento Madeira - Parket  
Sol Bois - Parquet Flottant  
Holz- und Parkettboden  
Piso Madera - Parquet  
实木 - 拼花地板

**WHEELS**

Rodas | Roues | Rollen | Ruedas | 轮子



COD. **RD001**

**HEADREST**

Repousa Cabeça | Repose Tête | Kopfstütze | Repoza Cabezas | 头枕



**VERY IMPORTANT ADVICE**

Conselho muito importante | conseil très important | wichtige hinweise | consejo muy importante | 非常重要的建议

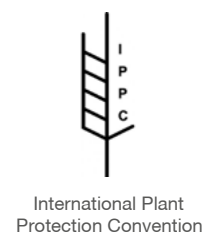

International Plant  
Protection Convention

For small quantities, we recommend always the use of pallets;  
Para pequenas quantidades, nós recomendamos sempre o uso de paletes;  
Pour de petites quantités nous conseillons toujours la palettisation;  
Für Kleinmengen, empfehlen wir stets Lieferung in Paletten;  
Para pequeñas cantidades recomendamos siempre el uso de palets de madera;  
非常重要的建议 数量少的订单,我们建议使用托盘包装。



## MAINTENANCE AND CLEANING ADVICE

Conselhos de Manutenção e Limpeza | Conseil d'Entretien de Néttoyage | Produkt- und Pflegehinweise | Consejos de Mantenimiento y Limpeza  
家家具清洁和维护建议 具清洁和维护建议

### WOOD AND VENEER

Madeira e Folheado | Bois et Placage | Holz und Furnier | Madera y Chapeado de Madera

- EN**
- Wood and veneer are affected by light and sources of heat. For the first 6–8 weeks, when the item is absorbing the surrounding light, keep the surfaces clear of any objects to avoid permanent marks and circles.
  - Protect wood and veneer from direct sunlight to prevent colour fading
  - Water must be used in small quantities and only in the form of a damp cloth. After wiping, always use a dry cloth
  - Wood and veneer are very sensitive to liquids. Wipe up spilled liquids immediately
  - Always try to remove stains with the mildest cleaning materials. A suitable soap solution is made from ¼ dl soap powder to 1 litre of warm water
  - Never use the agents containing benzene and other solvents.

- PT**
- A madeira e o folheado são afectados pela luz e pelo calor. Durante as primeiras 6 a 8 semanas, quando o produto estiver a absorver inicialmente a luz circundante, mantenha as superfícies livres de quaisquer objectos para evitar marcas e círculos permanentes.
  - Proteja a madeira e o folheado da luz solar directa para prevenir o esbatimento das cores.
  - Só deve usar-se água em pequenas doses e apenas num pano húmido. Depois de limpar, use sempre um pano seco.
  - A madeira e o folheado são sensíveis aos líquidos. Limpe imediatamente líquidos derramados.
  - Tente sempre remover manchas usando o material de limpeza mais suave. Uma solução de sabão adequada é constituída por ¼dl de sabão em pó por 1 litro água quente.
  - Nunca utilizar produtos que contenham benzeno ou outros solventes.

- FR**
- Les bois et placages peuvent être altérés par la lumière et par les sources de chaleur. Il est conseillé de ne pas poser d'objet sur votre nouveau meuble les 6 à 8 premières semaines pendant lesquelles il est exposé à la lumière du soleil, afin d'éviter les marques.
  - Protégez le bois et le placage de la lumière directe solaire afin d'éviter la décoloration.
  - L'eau doit être utilisée avec parcimonie et seulement avec un chiffon. Après l'essuyage, utilisez toujours un chiffon sec.
  - Les bois et placages sont très sensibles aux liquides. Essayez immédiatement les éclaboussures.
  - Essayez toujours d'éliminer les tâches avec les produits les plus doux. Une solution savonneuse correcte contient 25 dl de lessive par litre d'eau chaude.
  - Ne jamais utiliser des agents contenant du benzène et autres solvants.

- DE**
- Holz und Furnierholz werden durch Licht und Wärme beeinflusst. Während der ersten 6 bis 8 Wochen nimmt das Produkt die ersten Lichtstrahlen an, deshalb empfehlen wir die Oberflächen von Gegenständen freizuhalten um Abdrücke zu vermeiden.
  - Bitte das Holz und Furnier nicht der direkten Sonneneinstrahlung aussetzen. Farbveränderungen möglich.
  - Bei der Pflege aller Holzmöbel ist besonders darauf zu achten, dass diese niemals nass, sondern nur mit einem feuchten Tuch ohne Zusatz von Pflegemitteln gereinigt werden dürfen.
  - Die Fläche muss sofort getrocknet werden, da es sonst zu Lackschäden kommen kann.
  - Versuchen Sie immer , zum entfernen der Flecken, sanfte Reinigungsmittel zu benutzen. Geeignete Seifenlösung besteht aus 1/4 dl Seife pro 1 L warmes Wasser.
  - Niemals Produkte mit Benzol oder andere enthaltenden Lösungsmittel benutzen.

- ES**
- La luz y las fuentes de calor afectan a la madera y a la chapa de madera. Durante las primeras seis a ocho semanas, cuando el mueble está absorbiendo por primera vez la luz que lo rodea, no colocar objetos ni ningún tipo de decoración sobre las superficies. La absorción irregular de luz puede producir marcas y círculos permanentes.
  - Proteger la madera y el chapeado de la luz directa solar para prevenir el desvanecimiento de los colores.
  - Sólo se ha de utilizar agua en pequeñas cantidades y únicamente aplicándola con un paño húmedo. Después del paño húmedo, pasar siempre un paño seco.
  - La madera y la chapa de madera son muy sensibles a los líquidos. Por lo tanto, hay que limpiar inmediatamente el líquido que se derrame sobre ellas.
  - Intentar siempre a eliminar las manchas con los productos de limpieza más suaves. Una solución jabonosa adecuada está formada por ¼ dl de jabón en polvo por 1 litro de agua tibia.
  - Nunca usar los agentes que contengan benceno y otros solventes.

### CN

- 实木和木皮可因光线和热源而改变。在开始的6-8当产品吸收周围的光时，请保持表面不要放置任何物品以避免永久的标记和痕迹。
- 防止实木和木皮直接暴露于太阳底下，以免掉色。
- 不可用大量水来擦拭，仅用潮湿毛巾擦拭。用完湿布后，请用干毛巾抹干。
- 实木与贴皮表面对液体十分敏感，若溢出液体，请马上擦拭。
- 对于很难移除的污点要用温和的清洁剂擦拭，最合适的解决方法是用1/4的肥皂融合在1公斤的温水中，然后再擦拭
- 请不要使用苯溶剂和带有此成分的产品擦拭家具。



### IRON STAINLESS STEEL

Ferro/ Aço Inox | Fer/Acier Inoxydable | Eisen / Edelstahl | Hierro/Acero Inoxidable | 钢铁质产品

- EN**
- Wipe the whole surface with a clean, soft cloth wrung in soapy water;
  - Wipe dry with a clean cloth.

- PT**
- Limpe suavemente toda a superfície com um pano limpo, macio e humedecido com água com sabão neutro;
  - Limpe, de seguida, com um pano seco.

- FR**
- Essuyez légèrement toute la surface avec un chiffon doux et propre, imbibé d'eau savonneuse;
  - Utilisez un chiffon doux et sec.

- DE**
- Reinigen Sie die gesamte Oberfläche mit einem sauberen, weichen Tuch, das mit Wasser und einer milden Seifbefeuchtet ist,
  - Danach mit einem fusselfreien Tuch trocken nachwischen.

- ES**
- Limpiar suavemente toda la superficie con un trapo suave y limpio mojado en agua jabonosa suave y bien escurrido;
  - Secar con un paño limpio.

- CN**
- 拧干沾有肥皂水的布来擦拭表面
  - 用干净的干布来擦拭



### FABRICS

Tecidos | Tissus | Stoffe | Telas | 面料

- EN**
- Protect the fabric from direct sunlight to prevent colour fading
  - Never rub the stains and clean immediately;
  - Ordinary cleaning: Vacuum frequently and use a damp cloth;
  - Never use the agents containing benzene and other solvents;
  - Removable covers should be dry-cleaned.

- PT**
- Proteja o tecido da luz solar directa para prevenir o esbatimento das cores;
  - Nunca esfregue as manchas e limpe antes de secar;
  - Aspire com frequência e use apenas um pano húmido;
  - Nunca utilizar produtos que contenham benzeno ou outros solventes;
  - As capas removíveis devem ser limpas a seco.

- FR**
- Protégez vos tissus de la lumière du soleil pour empêcher que les couleurs ne perdent de leur éclat;
  - Ne jamais frotter les tâches et les nettoyer avant qu'elles ne sèchent;
  - Entretien courant. Passez souvent l'aspirateur et utilisez un chiffon;
  - Ne jamais utiliser des agents contenant du benzène et autres solvants;
  - Les housses amovibles doivent être nettoyées à sec.

- DE**
- Bitte die Stoffe nicht der direkten Sonneneinstrahlung aussetzen. Farbveränderungen möglich;
  - Reiben Sie niemals die Flecken; sofort säubern;
  - Gewöhnliche Reinigung: regelmäßig saugen und benutzen Sie nur ein feuchtes Tuch;
  - Niemals Produkte mit Benzol oder andere enthaltenden Lösungsmittel benutzen;
  - Abnehmbare Bezüge müssen trocken gereinigt werden.

- ES**
- Proteger la tela de la luz solar directa para prevenir el desvanecimientode los colores;
  - Nunca frotar las manchas;
  - Limpieza normal: limpiar con aspirador y con un paño húmedo;
  - Nunca usar los agentes que contengan benceno y otros solventes;
  - Las fundas extraíbles deben limpiarse en seco.

### CN

- 保护家具免受太阳直接照射，以免褪色
- 千万不要擦污渍和清洁紧接
- 正常清洗：经常吸尘和用略带潮湿的布擦
- 不要使用苯溶剂和带有此成分的产品擦拭家具
- 椅套可干洗

## FAUX LEATHER

Semi Peles | Simili Cuir | Kunstleder | Polipieles | 半皮革面料

- EN**
- Protect the faux leather from direct sunlight and sources of heat to prevent colour fading;
  - For general cleaning only use a dry soft cloth;
  - Never rub the stains;
  - Never use the agents containing benzene and other solvents;
  - If necessary, wipe the whole surface with a clean, soft cloth wrung in soapy water;
  - If vacuum cleaning, use a soft brush nozzle to avoid scratching the surface;
  - Pay attention to the migration of dyes.
- PT**
- Proteja as semi peles de fontes de calor e da luz solar directa;
  - Para a limpeza geral use apenas um pano macio e seco;
  - Nunca esfregue as manchas e limpe antes de secar;
  - Nunca utilizar produtos que contenham benzeno ou outros solventes;
  - Se for necessário, limpe suavemente toda a superfície com um pano limpo, macio e humedecido com água com sabão;
  - Se aspirar, use um bocal com escova macia para evitar riscar a superfície;
  - Ter atenção à migração das tinturas.
- FR**
- Tenez le simili cuir à l'écart de la lumière du soleil ou des sources de chaleur, pour empêcher que les couleurs ne perdent de leur éclat;
  - Utilisez un chiffon doux et sec pour le nettoyage courant;
  - Ne jamais frotter les tâches;
  - Ne jamais utiliser des agents contenant du benzène et autres solvants;
  - Si nécessaire, essuyez légèrement toute la surface avec un chiffon doux et propre, imbibé d'eau savonneuse;
  - Passez l'aspirateur avec un embout brosse douce pour éviter d'érafler la surface;
  - Faire attention au transfert des teintures.
- DE**
- Bitte schützen Sie Kunstleder vor der direkten Sonneneinstrahlung und von anderen Wärmequellen;
  - Für die allgemeine Reinigung nur ein trockenes, weiches Tuch benutzen;
  - Die Flecken niemals reiben;
  - Niemals Produkte mit Benzol oder andere enthaltenden Lösungsmittel benutzen;
  - Falls notwendig, wischen Sie die gesamte Oberfläche mit einem sauberen, weichen Tuch, das mit Seifenwasser angefeuchtet ist;
  - Falls Sie saugen, benutzen Sie eine feine Staubsaugerbürste um Kratzer auf der Oberfläche zu vermeiden. Sanfte Reinigungsmittel benutzen, wie z. B. Wasser und Seife;
  - Achten Sie auf die Migration von Farbstoffen.
- ES**
- Proteger la polipiel de la luz solar directa y de las fuentes de calor;
  - Para la limpieza general, utilizar únicamente un paño suave seco;
  - Nunca frotar las manchas;
  - Nunca usar los agentes que contengan benceno y otros solventes;
  - Si es necesario, limpiar suavemente toda la superficie con un trapo suave y limpio mojado en agua jabonosa y bien escurrido;
  - Si limpiar con el aspirador, utilizar una boquilla de cepillo suave para no rayar la superficie;
  - Prestar atención a la migración de los colorantes.
- CN**
- 防止半皮革制品受到太阳直射和其他热源，以免颜色掉落
  - 用干软布来进行正常擦拭。
  - 不要用力擦拭污垢
  - 不要使用苯溶剂和带有此成分的产品擦拭家具。
  - 如果用吸尘器清洁，用软扫来吸尘，防止刮花表面
  - 如有需要，请用软的沾有肥皂水的干净布来擦拭。



**We waive all responsibility for problems that arise out of ignoring the cleaning instructions.**

**Estamos isentos de qualquer responsabilidade por problemas originados pelo incumprimento das instruções de lavagem, utilização e manutenção.**

**Nous dégageons toute responsabilité quant aux problèmes encourus liés au non respect des consignes d'entretien.**

**Wir übernehmen keine Verantwortung oder Haftung für Probleme oder Schäden in jeglicher Form die durch die Nichtbeachtung der Reinigungshinweise entstehen.**

**Renunciaremos a toda responsabilidad por los problemas que surgen de ignorar las instrucciones de limpieza.**

不当清洁引起的问题不在我们质保范围内。

**All technical details are for reference only and are based on the example shown in the picture. The company reserves the right to change or amend any product show at any time, even without prior notice.** Toda a informação técnica é só de referência e baseada no modelo da foto. A empresa reserva-se o direito de modificar ou alterar em qualquer momento os produtos sem aviso prévio. Tous les détails techniques sont uniquement pour information et sont basés sur les modèles de la photo. L'entreprise se réserve le droit de modifier ou changer à tous moments les produits sans préavis. Alle technischen Informationen sind nur als Referenz, und basierend auf der Abbildung des Fotos. Wir behalten uns das Recht zur Änderung der Produkte ohne Vorankündigung. Todos los detalles técnicos son para referencia solo y se refieren al modelo en la foto. La empresa se reserva el derecho de modificar o cambiar en cualquier momento los productos sin avisar con antelación.

**Our complete product range is solely meant to be used indoor. Please do not ever put our items outside.**

Toda a nossa gama de produtos foi desenhada para ser utilizada no interior. Por favor nunca os coloque no exterior. Notre gamme complète de produits est uniquement destinée à être utilisée à l'intérieur. Merci de ne jamais mettre nos articles à l'extérieur. Unsere komplette Produktpalette ist ausschließlich für den Innenbereich gedacht. Unsere Artikel niemals in den Außenbereich stellen. Toda nuestra gama de productos está diseñada para ser utilizada en el interior. Por favor, no los ponga nunca en el exterior.

**Copyright.: Any reproduction of text or pictures is strictly forbidden without former written authorization from the company.**

Direitos de Autor.: a reprodução de texto ou imagem é estreitamente proibida sem a autorização escrita da empresa. Droit d'auteur.: Toute reproduction de texte ou d'images est strictement interdite sans autorisation écrite de l'entreprise. Urheberrecht: Wiedergabe von Text oder Bild ist ohne schriftliche Genehmigung der Firma verboten. Derechos de autor.: La reproducción del texto o imágenes está estrictamente prohibida sin autorización escrita de la empresa.

**All models are registered and patented**

Todos os produtos estão registados e patenteados  
Marque et modèles déposés, tous droits réservés  
Alle Marken sind registriert und patentiert  
Todos los modelos están registados y patentados

certificação



apoios



100% MADE IN PORTUGAL

[www.fenabel.pt](http://www.fenabel.pt)

//

care